

KFKI 3/2008

Z. Hózer
L. Matus
N. Vér
I. Nagy
P. Windberg
M. Kunstár
B. Alföldy
A. Pintér
O. Prokopiev
B. Tóth
K. Müller

**RUTHENIUM OXIDATION IN HIGH
TEMPERATURE AIR AND RELEASE
OF GASEOUS RUTHENIUM OXIDES**

**CENTRAL
RESEARCH
INSTITUTE FOR
PHYSICS**

BUDAPEST

RUTHENIUM OXIDATION IN HIGH TEMPERATURE AIR AND RELEASE OF GASEOUS RUTHENIUM OXIDES

**Zoltán Hózer^{a,*}, Lajos Matus^a, Nóra Vér^a, Imre Nagy^a, Péter Windberg^a,
Mihály Kunstár^a, Bálint Alföldy^a, Anna Pintér^a, Oleg Prokopiev^b, Béla Tóth^c, Klaus Müller^c**

^aHungarian Academy of Sciences KFKI Atomic Energy Research Institute
H-1525 Budapest, P.O. Box 49, Hungary

^bMexico State University
MSC 3450, Las Cruces, New Mexico 88001, P.O. Box 30001, USA

^cJoint Research Centre of the European Commission, Institute for Energy
NL-1755 ZG Petten, P.O. Box 2, The Netherlands

Abstract

Z. Hózer, L. Matus, N. Vér, I. Nagy, P. Windberg, M. Kunstár, B. Alföldy, A. Pintér, O. Prokopiev, B. Tóth, K. Müller: RUTHENIUM OXIDATION IN HIGH TEMPERATURE AIR AND RELEASE OF GASEOUS RUTHENIUM OXIDES

The RUSSET experimental programme was launched in order to study Ru oxidation and release from fuel in high temperature air. More than forty small scale tests have been performed with mixed powder components of inactive materials and with short fuel rods. The influence of temperature, air flow rate and the presence of other fission products on the gaseous Ru release and the retention role of fuel pellets and cladding have been investigated. The test series indicated that if an air ingress type severe accident occurs most of the initial Ru mass can be released from the reactor core to the containment or environment. Some part of the released gaseous Ru undergoes precipitation and deposits on the cold surfaces, another part is released in gaseous form. The deposited Ru oxides can serve as a secondary source for further gaseous Ru release

Kivonat

Hózer Z., Matus L., Vér N., Nagy I., Windberg P., Kunstár M., Alföldy B., Pintér A., Prokopiev O., Tóth B., Müller K.: RUTÉNIUM OXIDÁCIÓ MAGAS HŐMÉRSÉKLETŰ LEVEGŐBEN ÉS GÁZNEMŰ RUTÉNIUM OXIDOK KIBOCSÁTÁSA

A RUSSET kísérleti programban a ruténium oxidációját és kikerülését vizsgáltuk az atomerőművek fűtőelemeiből magas hőmérsékletű levegőn. Több mint negyven kisléptékű kísérletre került sor nem radioaktív izotópokból álló keverékekkel és rövid fűtőelem rudakkal. A mérésekben vizsgáltuk a hőmérséklet, a levegő forgalom és a más hasadási termékek hatását, valamint a tabletták és a burkolatok szerepét a gáznemű ruténium oxidok kibocsátására. A kísérletek jelezték, hogy ha légbetöréses baleset következik be egy atomerőműben, akkor a zónában található ruténium többsége kikerülhet a konténmentbe vagy a környezetbe. A gáznemű ruténium oxidok egy része lerakódik a hideg felületeken, míg másik része gázként távozik. A lerakódott ruténium oxidok szekunder forrást jelentenek a gáznemű oxidok képződéséhez.

Contents

1. INTRODUCTION	5
2. EXPERIMENTAL	6
2.1. Facility for powder tests.....	6
2.2. Test matrix of powder tests	7
2.3. Facility for short fuel rod tests	7
2.4. Test matrix of short fuel rod tests	8
2.5. Determination of ruthenium content in solutions.....	8
2.6. Measurement of deposited ruthenium.....	10
3. RESULTS AND DISCUSSION	10
3.1. Effect of temperature.....	11
3.2. Effect of air flow rate	11
3.3. Effect of other fission products on Ru release	12
3.4. Amount of gaseous Ru oxide release	12
3.5. Deposition of RuO ₂ on cold surfaces	12
3.6. Deposition of fission products on cold surfaces	13
3.7. Partial pressure of gaseous Ru oxides	14
3.8. Retention by fuel pellet	14
3.9. Effect of zirconium cladding.....	15
4. SUMMARY AND CONCLUSIONS	16
ACKNOWLEDGMENTS	16
REFERENCES	17

List of tables

TABLE 1. FISSION PRODUCT CONTENT OF SAMPLES	6
TABLE 1. TEST MATRIX FOR THE POWDER TESTS	19
TABLE 1. SUMMARY OF MAIN PARAMETERS OF THE SHORT FUEL ROD TESTS	20

List of figures

FIG. 1. SCHEME OF GAS SAMPLING DEVICE (BUBBLER).	21
FIG. 2. VIEW OF SHORT FUEL ROD SAMPLE.	21
FIG. 3. SCHEME OF TEST FACILITY FOR SHORT FUEL ROD TESTS.	22
FIG. 4. SCHEMATIC VIEW OF RU OXIDATION AND RELEASE MECHANISMS.	22
FIG. 5. INTEGRATED RELEASE OF GASEOUS RU OXIDE AS A FUNCTION OF TIME FOR THREE VARIOUS ISOTHERMAL OXIDATION TEMPERATURES; IN PERCENTS OF INITIAL MASS OF ELEMENTAL RU	23
FIG. 6. INTEGRATED GASEOUS RU OXIDE RELEASE AS A FUNCTION OF TIME FOR THREE VARIOUS GAS FLOW RATES AT 1100 °C.	23
FIG. 7. INTEGRATED GASEOUS RU OXIDE RELEASE FROM SAMPLES WITH AND WITHOUT ADDITIONAL FISSION PRODUCT SIMULANTS.	24
FIG. 8. INTEGRATED GASEOUS RU OXIDE RELEASE FOR ALL RUS-5 TESTS (BOTH POWDER AND SHORT FUEL ROD SERIES).	24
FIG. 9. RUO ₂ CRYSTALS PRECIPITATED IN THE GAS FLOW AND DEPOSITED ON THE INNER SURFACE OF A QUARTZ SAMPLER TUBE.	25
FIG. 10. CUMULATED MASS OF RU IN PRECIPITATIONS DEPOSITED ON THE SAMPLERS IN THE OUTLET SECTION AS A FUNCTION OF TIME; IN PERCENTS OF THE INITIAL RU MASS IN THE SIMULATED FUEL	25
FIG. 11. DEPOSITION OF FISSION PRODUCTS ON THE INNER SURFACE OF SAMPLERS IN THE OUTLET SECTION.	26
FIG. 12. AXIAL DISTRIBUTION OF DEPOSITED FISSION PRODUCT ELEMENTS ALONG THE 120-MM-LONG SAMPLING TUBE IN TEST RUS-5. THE WALL TEMPERATURE IS THE HIGHEST AT ZERO DISTANCE AND THEN IT GRADUALLY DECREASES.	26
FIG. 13. DIGITAL (BE) IMAGE OF NI PLATE EXPOSED TO THE EFFECT OF IODINE.	27
FIG. 14. THE PARTIAL PRESSURE OF VOLATILE RU OXIDES AS A FUNCTION OF RECIPROCAL TEMPERATURE. THE LINES SHOW THE EQUILIBRIUM PARTIAL PRESSURES; THE HOLLOW SYMBOLS REFER TO THE VALUES MEASURED IN THE TESTS	27
FIG. 15. INTEGRATED RU RELEASE FROM SHORT FUEL ROD SAMPLE	28

1. INTRODUCTION

Ruthenium is a very frequent fission product and large amount of this element accumulates in the core of nuclear reactors. The most important isotopes of ruthenium from radiological point of view are ^{103}Ru and ^{106}Ru with 39.3 day and 373.6 day half-life, respectively. The effect of radioactive Ru isotopes during severe reactor accident can be comparable to the consequences of release of iodine and caesium isotopes.

Ruthenium belongs to platinum metals group and has negligible vapour pressure even at very high temperatures. Ruthenium oxidises only at high oxygen potential, its most important oxides are RuO_2 , RuO_3 and RuO_4 . RuO_2 is a solid compound, it decomposes only above 1500 °C. RuO_3 and RuO_4 are volatile gaseous oxides. RuO_3 is not a stable compound and it exists only above 900 °C. Ruthenium is present in metallic form in nuclear fuel inside of white inclusions with other noble metals [1, 2].

Earlier experiments (AECL [3], VERCORS [4, 5] and PHEBUS [6]) indicated that during severe accident conditions the ruthenium release from fuel rods is possible and some specific tests showed that the gaseous ruthenium oxide release strongly increases in air ingress accidents. Furthermore the significant concentration of ^{106}Ru found in the soils around Chernobyl [7] confirms the high Ru release during this accident. Small-scale experiments demonstrated that uranium particles put in contact with air can release 100% of radio-ruthenium at temperatures of about 1000 °C [8].

Because of the radiological importance of Ru release and in order to support model development for the severe accident codes new experimental programmes have been launched in various European laboratories [9, 10]. The KFKI Atomic Energy Research Institute (AEKI) is carrying out the RUSSET (RUthenium Separate Effect Tests) experiments to investigate the release of ruthenium and other fission products in the presence of air. The current test programme included two series of experiments:

- Powder tests with non-active fission product simulants dispersed in ZrO_2 or UO_2 powder; they are conducted at constant temperature set between 1000 and 1200 °C. The released fission products were collected and their composition and amount was determined in the post-test examinations.
- Tests on short fuel rod segments containing fuel pellets with non-active fission product simulants. The applied temperature was in the range between 1300 and 1800 °C. These experiments provided information on the retention of fission products by the fuel rod.

The first results of RUSSET tests are summarised in the present paper.

2. EXPERIMENTAL

2.1. Facility for powder tests

The first series of experiments was carried out with fission product simulants mixed in ZrO₂ powder. The samples contained the characteristic fission products, including both volatile and non-volatile components (Ru, Mo, Cs, I, Ba, Se, Sn, Ag, Sb, Cd, Te, Nd, Ce and Zr, see Table 1.) and were prepared as a mixture of powder components. The mixture composition represented a burnup of 44 MWd/kgU; similar powder composition was used in the SASCHA experiments at FZK [11].

Compound	Mass (%)
Cs ₂ CO ₃	0.39
CsI	0.07
BaCO ₃	0.42
Ru	0.48
CeO ₂	0.39
Mo	0.35
Se	0.006
Sn	0.01
Ag	0.009
ZrO ₂	0.56
Sb	0.003
Cd	0.02
Te	0.07
Nd ₂ O ₃	1,07
Total	3.85

Table 1. Fission product content of samples

The Ru containing mixture was placed into a quartz tube with a sample holder. First, the high temperature conditions were set in a vertical furnace. During the tests, air injection was started only when the furnace and the sample were heated up to the required target temperature. The quartz tube outlet was connected to a gas sampling device with a flexible Teflon tube. The gas supply system providing constant gas flow was connected to the furnace inlet. In some tests, a steam generator supplied vapour inflow. The furnace had a 150-mm-long section with stable and uniform temperature distribution; the applied maximum temperature was 1200 °C.

During the experiments, the released gaseous Ru was collected in two places in order to determine the amount of gaseous (RuO₄) and precipitated (RuO₂) components:

- at the area of precipitation, where an inner quartz tube was placed into the reaction chamber outlet tube. The mass of precipitations was measured by weighting of the quartz tube before and after the experiments. During some tests, the quartz tube was changed 4-5 times; with this method the precipitation process could be determined as function of time. This arrangement produced decreasing temperature profile in the outlet tube.
- in a gas sampling facility containing 5 bubblers in parallel, which operated one after the other. Before the bubblers, Ni and Si plates were placed in the glass tube to collect aerosol precipitations for later SEM investigations. Additionally, a quartz fibre filter was in the outlet gas stream to separate the aerosol components. The gaseous ruthenium oxide RuO₄ was absorbed 1 n HCl solution in form of RuCl₃·nH₂O. To improve the efficiency of absorption the tube endings in the absorber solution contained sintered glass plates (Fig.1).

2.2. Test matrix of powder tests

The powder test series included 19 experiments were performed with ~5 mg Ru metal powder mixed in 1 g of ZrO₂ powder. The temperature of isothermal tests was varied between 1000 and 1200 °C. In five tests, not only Ru, but other inactive fission product simulants were added to the powder mixture as well. Most of the tests were performed in air atmosphere, but in some cases 5% steam was added to represent wet air conditions. One test (Ru-11) was carried out in argon and steam atmosphere for reference purposes. The typical air flow rate was 171 ml/min (at 25 °C), but in some cases 60 ml/min and 300 ml/min flow rates were applied to study the effect of gas flow rate. In several tests, to investigate the role of other core materials UO₂ powder, stainless steel plate and Zr1%Nb cladding were added. The main parameters of the experiments are summarized in the test matrix (Table 2.).

2.3. Facility for short fuel rod tests

The short fuel rods samples consisted of 1-2 fuel pellets enclosed in Zr cladding. Most of the pellets were fabricated for these experiments and contained inactive fission product simulant materials. In some cases, original, fresh pellets were used and the fission products (FP) were added into the gap between the pellet and cladding.

The pellets have been prepared from the mixture of UO₂, Ru and other fission products powder compacted at high pressure. The same ratios of fission product simulants were applied as in the powder tests (Table 1.). From the mixture the mass for one pellet has been separated and weighted at every case. A few drops diluted alkali-silicate solution was added and thoroughly mixed. This mixture was filled into a press tool. After one minute of high pressure treatment the pellet was pushed out from the tool and dried. High temperature heat treatment (sintering) was not applied because some of the FP components were volatile and they would escape from the pellet at high temperature. The diameter of prepared pellets was 7.6 mm, the density of original pellets milled for the present work was 10.5 g/cm³, the density of pellets prepared as described above was 5.5 g/cm³. During the test the sample size significantly decreased (Fig. 2).

An inductively heated furnace was used to conduct short fuel rod tests (Fig. 3). The

maximum temperature in the furnace was above 1800 °C which is much higher than in case of powder tests. The samples used for the experiments did not contain enough metal to absorb the necessary inductive power, for this reason a tungsten ring was placed around the high temperature section. The inner part of the furnace was made of an aluminium-oxide ceramic tube. ZrO₂ ceramic thermal isolation was applied around the aluminium-oxide tube. The high temperature section was placed into an external quartz tube containing high purity argon to prevent tungsten oxidation. The inlet gas was mixed from high purity argon and air, in some cases also steam was added. The gas flow rate was measured with pressure difference, using liquids in U tubes connected to the two ends of capillaries. The outlet junction of the furnace was connected to the sampling system. The released ruthenium oxides were collected in two positions similarly to powder test. Alumina tubes were placed at the outlet section of the furnace and gas samplers (see Fig. 3) containing diluted hydrochloric acid or alkaline hypochlorite in the cold section of the outlet flow. Both the outlet alumina tube and the acidic solution were changed at every 1/2 - 1 hour. 5 pieces of alumina tubes and 5 absorption devices were prepared for each test.

2.4. Test matrix of short fuel rod tests

In the short fuel rod test series 22 experiments were performed, of which 20 with short fuel rod samples and two with powder samples (Table 3). The powder samples (Rus-16 and Rus-17) were used to test the facility and check the Ru mass balance closure. The experiments were performed at a temperature set between 1300 and 1800 °C.

The first short fuel rod tests were carried out in pure air flow and led to temperature escalation. Therefore, the atmosphere was changed from air to air+Ar mixture with O₂ partial pressure set between 0,046-0,075 bars. In some cases steam was added to the atmosphere in order to simulate wet air conditions. Control tests have been performed without air in the atmosphere (Rus-20a and Rus-20b).

Some fuel samples contained two pellets and were placed into a closed cladding tube. As those tests indicated no Ru release, the cladding length was decreased, only one pellet was used and the inner cladding diameter was increased in the later experiments. Both E110 and Zircaloy-4 claddings were used, their inner diameter was 7.8 mm and 9.5 mm, respectively. In case of Zircaloy-4 the pellet-to-cladding gap was larger and it facilitated the access of air to the pellet surface. In several tests the cladding was artificially split open to simulate cladding burst.

2.5. Determination of ruthenium content in solutions

The determination of ruthenium content in solutions was based on spectrophotometric method.

In the first tests, 1 M HCl solutions were used as a liquid absorbing gaseous Ru oxides. The ruthenium concentrations were measured by spectrophotometer without any additional treatment of the liquid. It turned out that these hydrochloric acid ruthenium solutions were not stable; during several days their colour was changing, presumably as a result of very slow complex formation. The spectrophotometric measurements were made at the absorbance wavelength of 450 nm.

In the later tests, alkaline hypochlorite solution was applied and the method developed by Larsen and Ross [12] has been found to be the most convenient. According to this method sodium perruthenate was the species to be measured in alkaline solution containing hypochlorite with low concentration. If the alkaline concentration was about 1 M and the hypochlorite was 0.05 M the ruthenium was in septivalent form (perruthenate) and stable for many days. Without hypochlorite a slow reaction towards ruthenate formation makes the colour of solution unstable, in case of too much hypochlorite a slow escape of RuO₄ takes place. The change of colour did not exceed 0.3 %/day in terms of concentration. These measurements were made also at 380 nm absorbance value.

The partial pressure of RuO₄ in the released gas was calculated from the amount of Ru in the absorber solution and the volume of integrated gas flow. The following equations of equilibrium partial pressures for RuO₄ and RuO₃ [13, 14] were used.

$$\text{RuO}_4: \quad \lg(K_p) = -6219.4/T + 4.2120 - 1.0315\lg(T) - 0.0557 \cdot 10^{-5} / T^2 \quad (1)$$

$$\text{RuO}_3: \quad \lg(K_p) = -12968.5/T + 10.1385 - 1.2429\lg(T) - 0.1399 \cdot 10^{-3}T + 0.033 \cdot 10^5 / T^2 \quad (2)$$

with K_p (atm) and T (K).

Using the equations (1) and (2) the temperature was calculated, where the RuO₄ → RuO₂ + O₂ chemical reaction stopped.

2.6. Measurement of deposited ruthenium

Large amount of released ruthenium deposited on the quartz and alumina tubes in the outlet section of furnaces. Along the approximately 19 cm long tubes the wall and gas temperatures decreased below 200 °C, which provided a cold surface for precipitation.

If the tests were carried out only with ruthenium, i.e. without other fission products, the mass gain of the sampler tubes was determined by the mass of deposited ruthenium dioxide.

In order to determine the mass of deposited elemental ruthenium when other fission products were present, the deposited oxides were reduced by applying a 5-hour heat treatment at 1100°C in a 5%H₂+ N₂ gas stream [15].

It is known that the metallic ruthenium is soluble in hypochlorite–NaOH solution, therefore the ruthenium metal was trapped by such a solution and the Ru-content of this solution was determined by spectrophotometric measurements.

The elemental analysis of deposits containing other fission products was carried out with XRF and SEM-EDX methods.

3. RESULTS AND DISCUSSION

The RUSSET experiments simulated the oxidation of elemental ruthenium, the release and transport of Ru oxides from fuel rods in high temperature air flow. The experimental facilities and the test conditions were built and selected to represent the main phenomena taking place during a severe reactor accident with air ingress (Fig.4).

During isothermal oxidation of metallic ruthenium samples, the furnace temperatures were set to a constant value between 1000-1800 °C. The air injection into the furnace resulted in the formation of gaseous ruthenium oxides: RuO₃ and RuO₄.

The outlet section of furnaces simulated the cold surfaces of the primary circuit and the temperature here decreased to 100 °C. At this temperature, the RuO₃ decomposed leading to formation of RuO₂ crystals on the cold surfaces; some part of RuO₄ also decomposed. When the air from the furnace entering the outlet section was sufficiently hot, RuO₄ was produced again through the oxidation of RuO₂ deposited on the wall.

A gas bubbler kept at room temperature represented the atmosphere of the containment or the environment. Here the gaseous RuO₄ was collected by a chemically reacting solution. . Some part of RuO₄ was released directly from the furnace, while another part from the outlet section where the deposited RuO₂ was further oxidised to volatile RuO₄.

The main results of the experiments are related to the identification and determination of gaseous Ru release. Several measurements were made to provide information on the deposition of Ru and other fission products elements on cold surfaces. The amount of

gaseous Ru oxide releases and the amount of Ru deposits (in form of RuO₂) was determined. In most of the powder tests, the sum of elemental ruthenium mass in the released gaseous Ru oxides and the deposits was close to the initial Ru mass placed in the furnace. . This means that all metallic Ru was oxidised in these tests.

In case of low temperature powder tests, the experimental facility was relatively simple and the deposition of released materials on hidden surfaces negligible. In the tests with short fuel rods, the experimental facility had a more complex geometry and the deposition in some hidden points was comparable to that of the deposition on the samplers. The amount of Ru remaining in the fuel sample was not measured. The Ru mass balance for the short fuel rod test facility was checked with special powder tests. According to these measurements, the mass of Ru deposited on the samplers and on the hidden surfaces were roughly equal to each other.

Control tests (Ru-11 at 1000 °C Rus-20a at 1600 °C and Rus-20b at 1700 °C), indicated that, in pure steam atmosphere, Ru oxides are not released in the investigated range of parameters, the formation of Ru oxides took place only in the presence of O₂.

The effects of temperature, gas flow rate, presence of other fission products and the retention by fuel were analysed in the test series. The detailed results will be presented in the next paragraphs.

3.1. Effect of temperature

The temperature had very significant effect on the oxidation and release of gaseous Ru oxide. The release of RuO₄ was much faster at high temperature than at low one. Typical results of the experiments are shown in Fig. 5. After 1 hour of isothermal oxidation at 1000 °C less than 1% of initial Ru mass was released (test Ru-6). At 1100 °C (Ru-5), the respective value is 2%, while at 1500 °C the released gaseous fraction reaches 7%. The release fractions show an approximately linear increase with time for 1000 and 1100 °C. However, for 1500 °C (test Rus-7) the last time point of does not fit the linear trend; this indicates that at this moment most of the elemental Ru was consumed, i.e. oxidized and released from the furnace. It must be noted that the compared samples were examined under slightly different conditions: in case of Rus-7 the quartz sampler tubes were replaced during the test and the initial composition contained not only Ru but other fission product simulants and UO₂ as well.

3.2. Effect of air flow rate

The effect of air flow rate was studied in three powder tests at 1100 °C. In these tests all parameters were the same except the imposed gas flow rate. The gaseous Ru oxide release was much lesser at a low flow rate than at a higher one. However the effect did not show a linear increase of Ru release with increasing air flow rate, the release grew faster than linear. Namely, the test with 300 ml/min flow rate produced ten times higher release than the test with 60 ml/min (Fig. 6). The gas flow rate effect can be explained by two phenomena:

- The equilibrium partial pressure of gaseous Ru oxides was reached in all experiments. In case of low flow rate the equilibrium partial pressure can be reached at the

oxidation of smaller Ru mass than in case of high flow rate, so the oxidation rate must be higher at high gas flow rate.

- The decomposition of $\text{RuO}_4 \rightarrow \text{RuO}_2 + \text{O}_2$ takes place in the short outlet section. In case of low gas velocity there is more time for this reaction and the decomposition is more complete than in case of high gas velocities. For this reason at high flow rates more RuO_4 remains in the gas stream and this leads to additional release.

3.3. Effect of other fission products on Ru release

The most significant difference between the tests with and without other fission product simulants was a delay in Ru release (Fig.7). If there were no other fission product materials in the powder mixture sample, the Ru release was detected already during the first sampling. The yellow colour indicating the presence of Ru in the solution of bubbler was observed very quickly after the beginning of the tests. If other fission products (see table 1.) were present in the sample the Ru release occurred later. This delay could be explained by some chemical reactions. However in this test series all the fission product elements were added together and those elements responsible for the delay could not be identified.

3.4. Amount of gaseous Ru oxide release

The amount of gaseous Ru oxide release to the room temperature outlet means the release of RuO_4 . The other gaseous oxide RuO_3 is not stable at low temperature and decomposes before reaching the room temperature sampler. The mass of released Ru in form of RuO_4 was determined in each test. The relative values shown in Fig. 8 are related to initial Ru mass in the sample.

No Ru release was found in the following cases:

- The atmosphere contained no air (only steam and/or argon).
- The fuel sample had a closed cladding that prevented the penetration of air to the surface with Ru content.

Fig. 8 shows that the maximum Ru release from some short fuel rods was about 20% and above 15% in some powder tests. This implies that in high temperature air flow a large amount of Ru could be released from a reactor core. However these values can not be used as maximum or limiting numbers. They were typical for the given tests considering the special conditions and test duration. (In the tests, where all Ru was released from the furnace further gaseous Ru oxide release could have been produced due to the oxidation of deposited RuO_2 .)

In the Ru-14 experiment, a quartz filter was placed at the top of the outlet section of the facility to study the possible aerosol release. There were no differences in the Ru contents of absorber liquids in tests Ru-13 (without filter) and Ru-14 performed in similar conditions and this fact indicated that no significant amount of Ru was carried away by aerosols in the tests.

3.5. Deposition of RuO_2 on cold surfaces

In the outlet section of the facilities with decreasing temperature profile ruthenium dioxide deposits were formed as a result of the following reactions: $\text{RuO}_4 \rightarrow \text{RuO}_2 + \text{O}_2$ and $\text{RuO}_3 \rightarrow \text{RuO}_2 + 1/2 \text{O}_2$. These reactions stopped at low temperature. The temperature range was calculated from the partial pressure of released RuO_4 . In the different tests the equilibrium temperature varied between 600-800 °C according to equations (1) and (2).

Fig. 9 shows a photo of a quartz tube with the morphology of crystalline deposits on it. The left side of the tube had higher temperature than the right one. At the high temperature part, the crystals with near spherical shape have been found, further along the tube at the lower temperature part needle-shaped crystals were growing from a centre on the tube wall. At the lower temperature end again sphere shaped, larger grains, further microcrystalline deposits can be seen.

In some tests the outlet sampler tubes were changed together with the absorber units. The weight increase showed how fast the Ru was released from the furnace. Two samples are shown in Fig. 10. In case of the powder test Ru-14, the sampling tubes were changed every 30 minutes. It is clearly seen that most of the precipitation/deposition took place during the first 30 minutes and only modest increase can be observed in the second period thereafter. Similar behaviour was observed in the case of short fuel rods tests, too. The time-dependent precipitation on the first three samplers in the test Rus-8 confirms that most of Ru was released from the furnace during the first sampling period (during 60 minutes).

In the Ru-13 and Ru-14 experiments, the quartz inlet tubes were changed at the same time as the absorbers. In the third and fourth absorber solutions there was no Ru. This proved that later, during the subsequent sampling period the Ru escapes were coming from the deposited RuO_2 by re-evaporation in the high temperature air flow.

3.6. Deposition of fission products on cold surfaces

Deposition of some fission product elements was observed in tests with short fuel rod samples and powder tests with fission product simulants. Deposition took place mainly in the outlet section of the facilities. The temperature in this section dropped from the temperature of the furnace to 100-200 °C in a 10-20 cm long distance.

Typical view of fission product deposition is shown in Fig. 11. The first two sets of quartz samplers (tube and rod together) indicates that during the first sampling period more materials were collected on the samplers than in the second one. Furthermore the deposition was limited by temperature, for the low temperature end of the samplers contained only few particles.

For determination of the axial distribution of the fission product elements deposited along the sampler rod, Micro-beam X-ray Fluorescence (μXRF) measurement has been carried out. An example is shown in Fig. 12. The axial distribution along the rod could be determined for four elements (Mo, Ru, Te and Cs) that were present in the pellet of test Rus-5. The first measurement point was taken close to the hottest end of the rod. The distribution curves of each element were normalised to the maximum count value. Zr and Nd were detected only in a few measurement points.

Due to the thermochromatographic effect Cs deposited first on the rod, Mo and Ru were the second and the third and Te the last. It means that deposition of Cs took part at the highest and Te at the lowest temperature in the outlet section of the furnace. Later Energy-Dispersive X-Ray (EDX) examination confirmed the finding of XRF analysis. For both of large regions and of small grains, the EDX analysis showed the deposition of Te, Ru, Mo, Cs and sometimes small amount of U and Cd.

The volatile fission products were able to pass the outlet section of facilities and deposited on the room temperature surfaces. The liquid sampler in test Ru-15 contained a Ni plate (see Fig.1) and traces of degradation caused by iodine were found on its surface: there were a lot of „corrosion” spots and in their neighbourhood small sized grains with globular shape were present. The size of these grains varied between about 1 micrometer and a few micrometers. These grains were arranged mostly in arrays (Fig. 13). Studies of the elemental composition of the corrosion spots revealed the presence of the following elements: Ni, O, I and small amount of Ru.

3.7. Partial pressure of gaseous Ru oxides

The partial pressures calculated on the basis of the sum of deposited Ru mass and Ru in liquid solutions characterized the conditions in the furnace. The calculated partial pressures were in very good agreement with the equilibrium partial pressure of $\text{RuO}_4 + \text{RuO}_3$ calculated by (1) and (2). The partial pressures of the Ru-oxides in air are plotted in Fig. 14. The agreement with the equilibrium data showed that both RuO_4 and RuO_3 reached saturated concentration in the furnace and this condition limited the rate of Ru oxidation.

The partial pressures calculated from the Ru mass trapped in liquid solutions characterized the Ru oxide concentration in room temperature atmosphere. These calculated partial pressures were much higher than the equilibrium partial pressure of $\text{RuO}_4 + \text{RuO}_3$ at room temperature. Namely, the experimental partial pressures were in the range of 10^{-7} - 10^{-5} bar, while the equilibrium value was lower by several orders of magnitude (10^{-19} bar). Obviously the decomposition process $\text{RuO}_4 \rightarrow \text{RuO}_2 + \text{O}_2$ was not fast enough to follow perfectly the equilibrium. The measured rate of decomposition slowed down with decreasing temperature and stopped at about 600-800 °C and below these temperatures the partial pressure did not change.

3.8. Retention by fuel pellet

In the short fuel rod test series special experiments were carried out to study the role of the pellet in the retention of Ru release. Two types of tests were performed:

- tests with fabricated pellets that contained the fission product simulants,
- tests with original pellet, the sample contained fission product simulants in the gap between the pellet and cladding.

At 1500 °C the total Ru release from fabricated pellets was 50-60% of initial Ru mass, while in the case of original pellets and fission products in the gap the total release was close to 100%. Experiments with fabricated pellets at 1800 °C resulted in more than

90-% total release. These facts indicate that pellets played considerable role in retention of Ru, but the retention was less significant at higher temperature.

The release of Ru from short fuel rod samples was delayed. Fig. 15 shows the integrated amounts of released gaseous Ru oxides and deposited RuO₂ on the sampler surface in test Rus-19 carried out at 1700 °C with a short fuel rod. Both curves indicate that intense Ru release started in more than one hour after the start of high temperature oxidation. The comparison of delay caused by fission products in the powder tests at 1100 °C (chapter 3.3. and Fig. 7) and delay observed in test Rus-19 (Fig. 15) shows that in the second case the intense release in spite of the higher temperature started later. It means that the delay was caused not only by the other fission products, but by the retention effect of fuel pellet and cladding, too.

3.9. Effect of zirconium cladding

The role of Zr cladding on Ru release was studied in the short fuel rod test series. The cross sectional view of a typical fuel sample with fully oxidised cladding, fragmented Zr oxides and sintered pellet is shown in Fig. 16. The main observations in these tests were the following:

- The cladding remained intact in several tests and completely prevented the release of fission products from the sample. Even the fully oxidised Zr was able to prevent any release. Due to the oxidation of cladding the original gap disappeared and there was no access of air to the pellet surface.
- In tests with split open cladding (long artificial crack along the cladding tube) or in tests with short cladding segment around the pellet, no delay of Ru release was recorded compared to tests with bare fuel pellets. The oxidation of Zr cladding and release of Ru took place at the same time if there was enough space for the access of air to the pellet surface.

The main conclusion on the retention effect of Zr cladding was related to the clad integrity. If the cladding remained intact, there was no Ru release, but if the cladding integrity was lost the release of Ru immediately started in high temperature air. (The presence of stainless steel was also studied in a special powder test, but no real effect could be identified in the applied facility and in the investigated range of parameters.)

4. SUMMARY AND CONCLUSIONS

In the RUSSET programme the oxidation and release of ruthenium were investigated in small scale experiments. The main observations and results of the tests were the followings [16]:

- a) Intense oxidation of metallic Ru took place in high temperature air. Gaseous Ru oxides were produced and released from the furnace (model of reactor core).
- b) The rate of Ru oxidation was limited by the sum of equilibrium partial pressures of RuO_4 and RuO_3 .
- c) RuO_2 deposits were formed on the cold surfaces of the outlet section (model of primary circuit) of test facilities as a consequence of decomposition of RuO_4 and RuO_3 .
- d) The decomposition of gaseous Ru oxides stopped at 600-800 °C and for this reason the partial pressure of gaseous Ru oxides in room temperature air was much higher than the equilibrium value. The released RuO_4 is not retained in the outlet test section; it reaches the end of gas sampling line (model of the containment or environment).
- e) Additional RuO_4 formation was detected in the outlet section as a result of oxidation of RuO_2 deposits in high temperature air atmosphere.
- f) The presence of other fission products delayed the release of ruthenium, but did not decrease the released mass.
- g) The most important factor in the retention of ruthenium release was the integrity of fuel rod cladding. If the cladding remained intact during the test (even if the Zr was completely oxidised), no ruthenium was released, since the high temperature air had no access to the pellets and the volatile oxides were not produced.

ACKNOWLEDGMENTS

The RUSSET experiments were supported by the Hungarian Atomic Energy Authority, (contract No.: OAH/NBI-ABA-05/02 and OAH/NBI-ABA-54/03) and by the Joint Research Centre of the European Commission, Institute for Energy (contract No.: 32.0227).

REFERENCES

- [1] Sato, H. Furuya, T. Arima, K. Idemitsu, K. Yamamoto, Behaviour of metallic fission products in uranium-plutonium mixed oxide fuel, *J. Nuc. Mat.* 273 (1999) 239-247.
- [2] S. Yamanaka, K. Kurosaki, Thermophysical properties of Mo-Ru-Rh-Pd alloys, *J. Alloys and Compounds* 353 (2003), 269-273.
- [3] R.D. Barrand, R.S. Dickson, Z. Liu, D. D Semeniuk, Release of fission products from CANDU fuel in air, steam and argon atmospheres at 1500-1900 °C, *Proc. Sixth Int. Conf. on CANDU Fuel*, Niagara Falls, Ontario, 1999
- [4] Y. Pontillon, P.P. Malgouyres, G. Ducros, G. Nicaise, R. Duborg, M. Kissane, M. Baichi, Lessons learnt from VERCORS tests, *J. Nuc. Mat.* 344 (2005) 265-273.
- [5] G. Ducros, P.P. Malgouyres, M. Kissane, D. Boulaud, M. Durin, Fission product release under severe accident conditions: general presentation of the program and synthesis of VERCORS 1-6 results, *Nucl. Eng. Des.* 208 (2001), 191-203.
- [6] R. Dubourg, H. Faure-Geors, G. Nicaise, M. Barrachin: Fission product release in the first two PHEBUS tests FPT0 and FPT1, *Nucl. Eng. Des.* 235 (2005), 2183-2208.
- [7] C. Ronneau, J. Cara, A. Rimski-Korsakov, Oxidation enhanced emission of ruthenium from nuclear fuel, *J. Environ. Radioactivity* 26 (1995) 63-70.
- [8] S.V. Krouglov, A.D. Kurinov, R.M. Alexakhin, Chemical fractionation of ⁹⁰Sr, ¹⁰⁶Ru, ¹³⁷Cs and ¹⁴⁴Ce In Chernobyl-contaminated soils: an evolution in the course of time, *J. Environ. Radioactivity* 38 (1998), 59-76.
- [9] A. Auvinen, U. Backman, J. Jokiniemi, M. Lipponen, E. Zilliacus, M. Kissane, I. Nagy, M. Kunstár, N. Vér, Investigation of ruthenium transport in highly oxidizing conditions, *Proc. Int. Conf. Nuclear Energy for New Europe 2005*, Bled, Slovenia
- [10] T. Haste, P. Giordano, L. Herranz, J.-C. Micaelli: SARNET: Integrating severe accident research in Europe – Safety issues in the source term area, *Proc. ICAPP 2006*, Reno, USA, paper 6300.
- [11] A. Albrecht: Final Report of SACHA Programme, Kfk 4264 (1987), (in German)
- [12] R. P. Larsen, L. E. Ross, Spectrophotometric determination of Ruthenium, *Analytical Chemistry* 31 (1959), 176-78.

- [13] Gmelins Handbuch der Anorganischen Chemie, Ruthenium, 63. Erg-band, Verlag Chemie GMBH, Weinheim/Bergstr., (1970).
- [14] H. Schafer, A. Tebben, W. Gerhardt, Zur Chemie der Platinmetalle V. Gleichgewichte mit $\text{Ru}_{(f)}$, $\text{RuO}_{2(f)}$, $\text{RuO}_{3(g)}$ and $\text{RuO}_{4(g)}$, Zeitschrift für anorganische und allgemeine Chemie, 321 issue 1-2 (1963), 41-55.
- [15] W. E. Bell, M. Tagami, High-temperature chemistry of ruthenium-oxygen system, J. Phys. Chem. 67(1963), 2432-2436.
- [16] M. Kunstár, L. Matus, N. Vér, A. Pintér, Z. Hózer, M. Steinbrück, J. Stuckert: Experimental Investigation of the Late Phase of Spent Fuel Pool Accidents, Int. J. Nuclear Energy Science and Technology, vol. 3. pp. 287-301 (2007)

Test	Temperature (°C)	Time (min)	Atmosphere	Gas flow-rate (ml/min)	Fission product simulants	Special conditions
Ru-1	1100	330	Air	60	Ru	
Ru-2	1100	360	Air	60	Ru	
Ru-3	1100	423	Air	166	Ru	
Ru-4	1100	480	Air	171	Ru	
Ru-5	1100	360	Air	300	Ru	
Ru-6	1000	483	Air	171	Ru	
Ru-7	1100	360	Air	171	Ru	SS plate in the outlet section
Ru-8	1200	270	Air	171	Ru	
Ru-9	1100	480	Air+5% steam	171	Ru	
Ru-10	1100	354	air	171	Ru	Zr pieces added to the matrix
Ru-11	1100	240	Steam+ Ar	171	Ru	Zr pieces added to the matrix
Ru-12	1100	480	Air+5% steam	171	Ru	
Ru-13	1100	90	Air	171	Ru	
Ru-14	1100	120	Air	171	Ru	Aerosol filter applied
Ru-15	1100	156	Air+5% steam	171	Ru+others	Aerosol filter applied
Ru-16	1100	150	Air	171	Ru+others	Aerosol filter applied
Ru-17	1100	405	Air+5% steam	171	Ru+others	
Ru-18	1100	420	Air+5% steam	171	Ru+others	UO ₂ added to the ZrO ₂ matrix
Ru-19	1100	300	Air	171	Ru+others	UO ₂ added to the ZrO ₂ matrix

Table 2. Test matrix for the powder tests

No.	Clad- ding	Type of pellet	Atmos- phere	Gas flow- rate ml/min	Temp e- rature °C	Time (min)	Special conditions
Rus-1	E110	fabricated	air+Ar	200	> 1800	80	
Rus-2	E110	fabricated	Ar	360	1300	30	
Rus-3	E110	fabricated	air+Ar	460	1500	150	cladding inner diameter 8 mm
Rus-4	no	fabricated	air+Ar	460	1500	456	
Rus-5	no	fabricated	air+Ar	460	1700	239	
Rus-6	no	fabricated	air+Ar	460	1500	170	
Rus-7	no	fabricated	air+Ar	460	1500	240	
Rus-8	Zircaloy	fabricated	air+Ar	460	1500	240	split open cladding
Rus-9	Zircaloy	original	air+Ar	560	1500	120	split open cladding, Ru in the gap
Rus-10	Zircaloy	original	air+Ar	560	1500	240	split open cladding, FP in the gap
Rus-11	no	fabricated	steam+ Ar+air	560	1500	180	
Rus-12	Zircaloy	original	steam+ Ar+air	600	1500	202	FP in the gap
Rus-13	E110	original	air+Ar	560	1500	150	FP in the gap
Rus-14	E110	original	air+Ar	560	1500	120	split open cladding, FP in the gap
Rus-15	E110	fabricated	air+Ar	560	1500	143	split open cladding, FP in the gap
Rus-16	no	no	air+Ar	550	1500	165	Ru+ZrO ₂ powder
Rus-17	no	no	air+Ar	550	1500	175	Ru+ZrO ₂ powder
Rus-18	Zircaloy	fabricated	air+Ar	550	1600	108	
Rus-19	Zircaloy	fabricated	air+Ar	550	1700	156	
Rus-20a	Zircaloy	fabricated	Steam+ Ar	350	1600	94	
Rus-20b				350	1700	180	
Rus-21	Zircaloy	fabricated	air+Ar	550	1600	180	
Rus-22	Zircaloy	fabricated	air+Ar	850	1800	180	

Table 3. Summary of main parameters of the short fuel rod tests

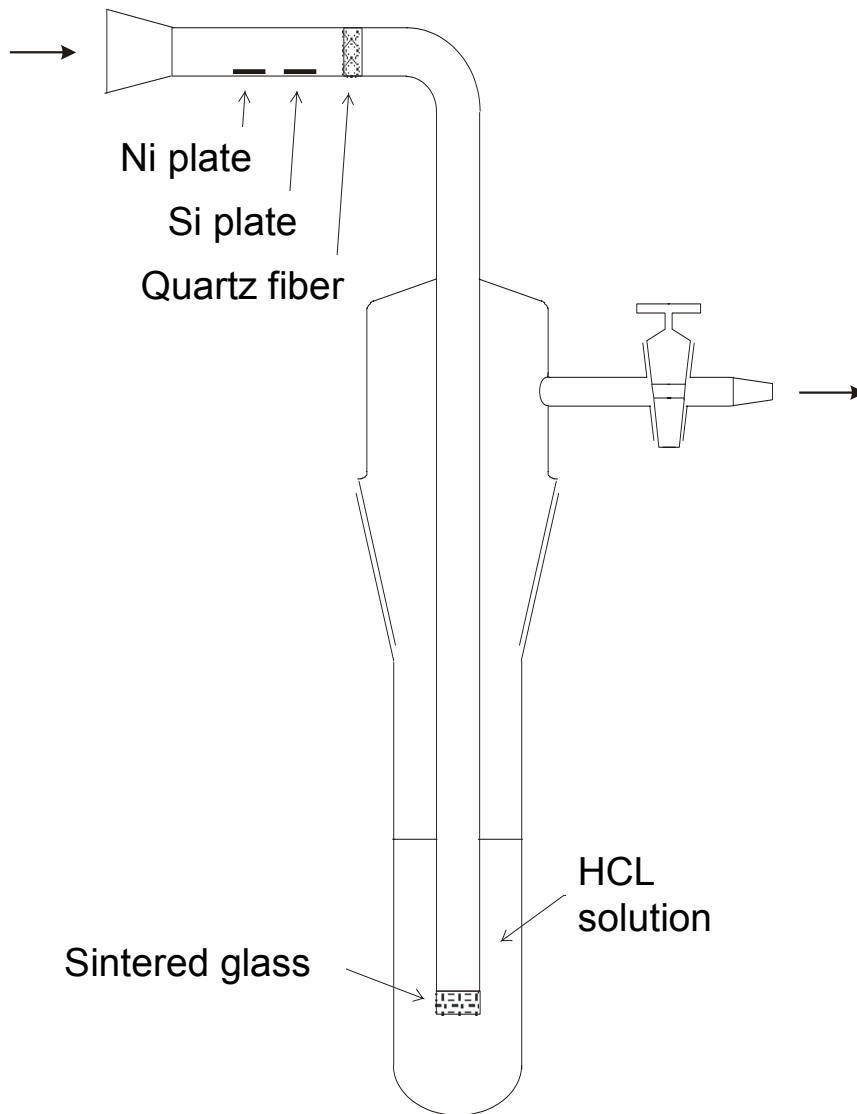

Fig. 1. Scheme of gas sampling device (bubbler).



Fig. 2. View of short fuel rod sample.

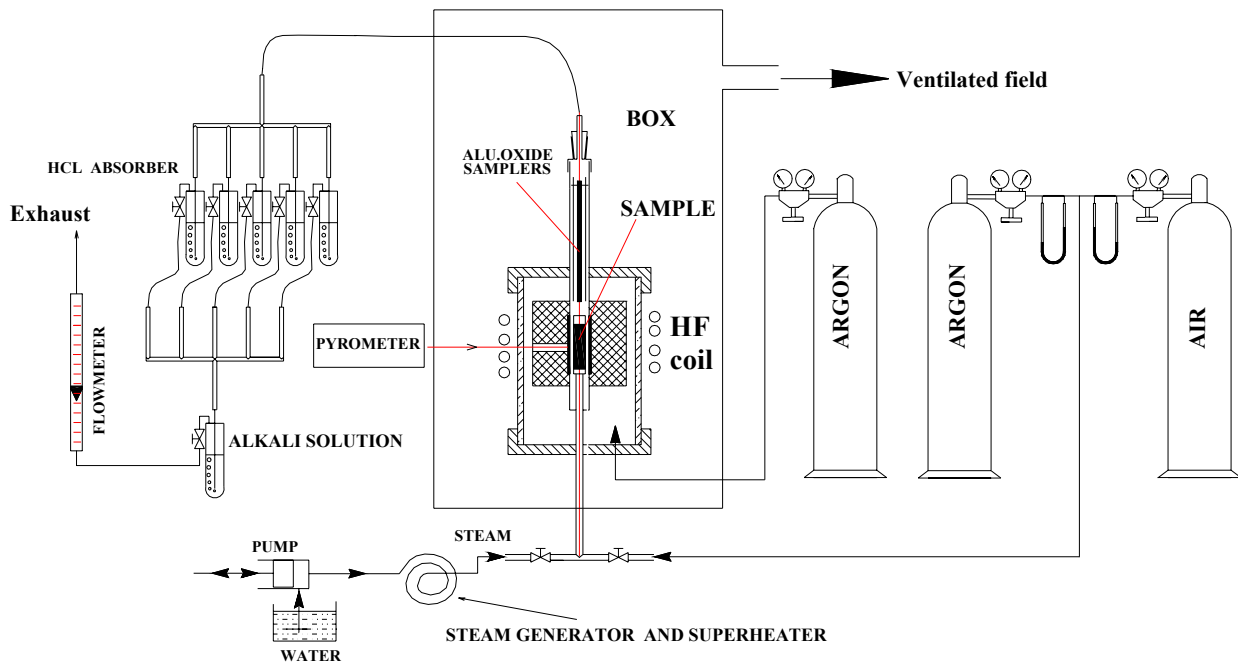

Fig. 3. Scheme of test facility for short fuel rod tests.

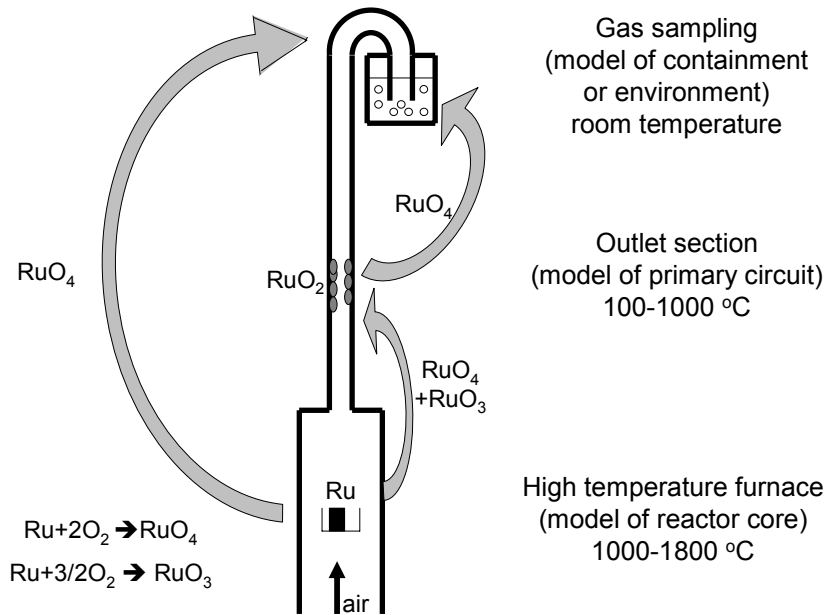

Fig. 4. Schematic view of Ru oxidation and release mechanisms.

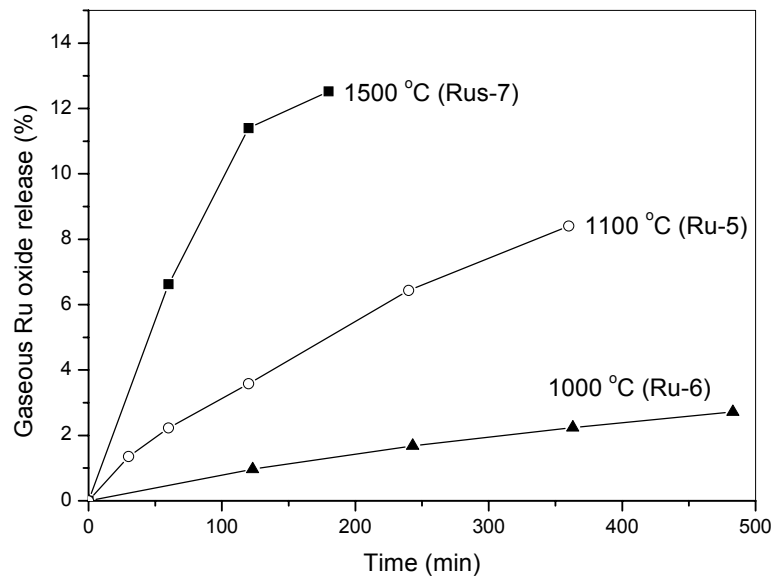

Fig. 5. Integrated release of gaseous Ru oxide as a function of time for three various isothermal oxidation temperatures; in percents of initial mass of elemental Ru

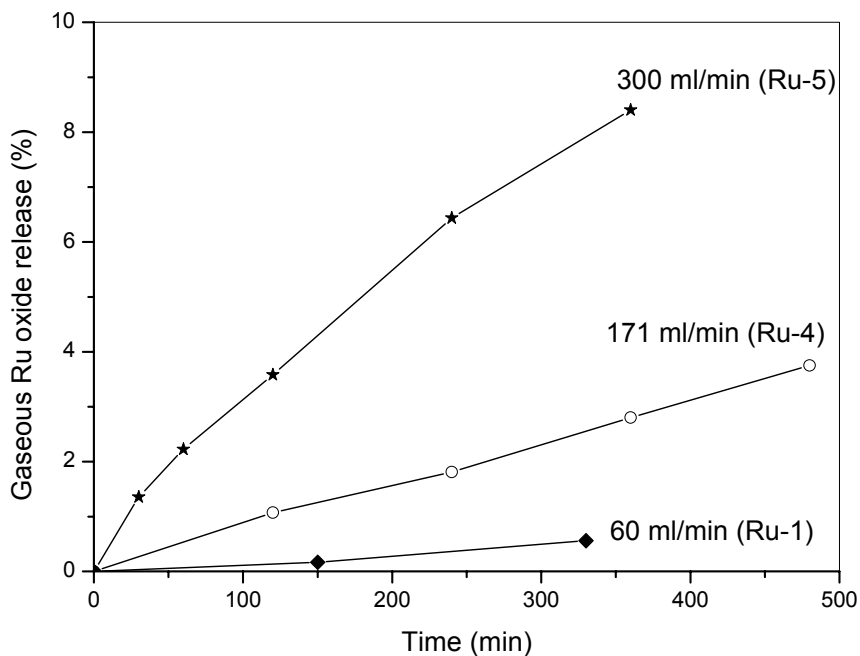

Fig. 6. Integrated gaseous Ru oxide release as a function of time for three various gas flow rates at 1100 °C.

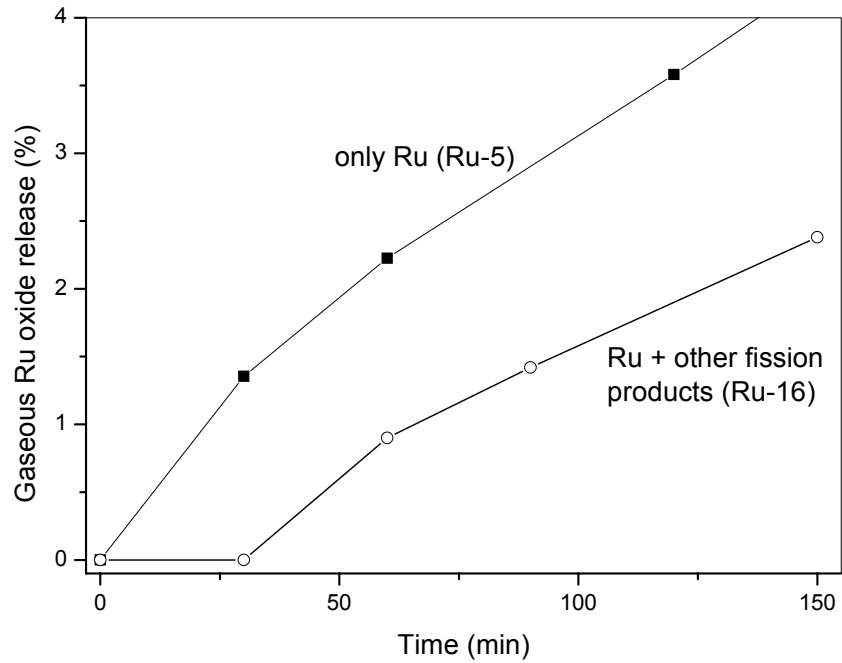

Fig. 7. Integrated gaseous Ru oxide release from samples with and without additional fission product simulants.

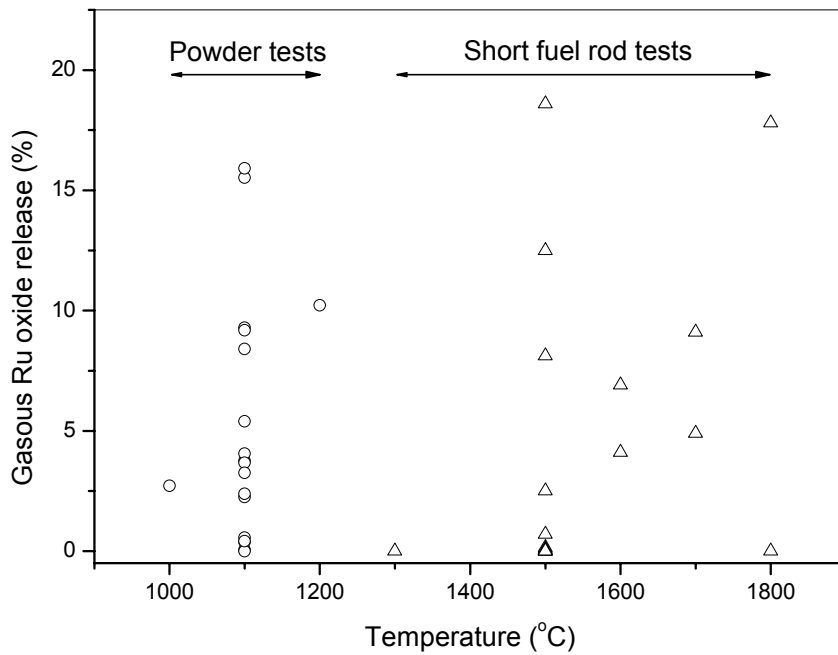

Fig. 8. Integrated gaseous Ru oxide release for all RUSSET tests (both powder and short fuel rod series).



Fig. 9. RuO₂ crystals precipitated in the gas flow and deposited on the inner surface of a quartz sampler tube.

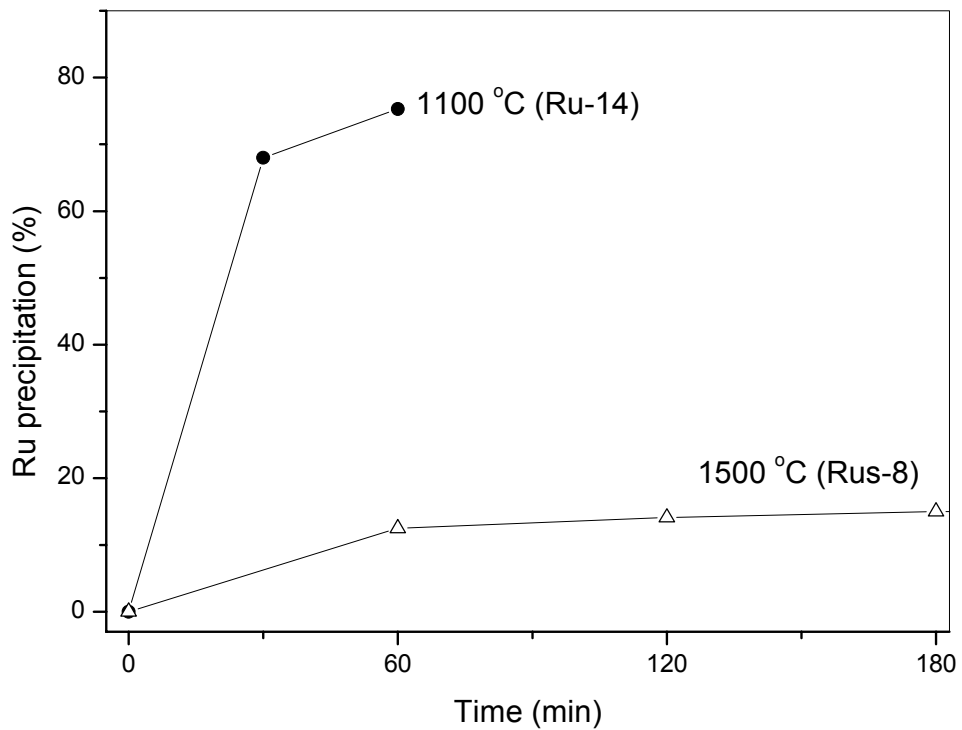

Fig. 10. Cumulated mass of Ru in precipitations deposited on the samplers in the outlet section as a function of time; in percents of the initial Ru mass in the simulated fuel

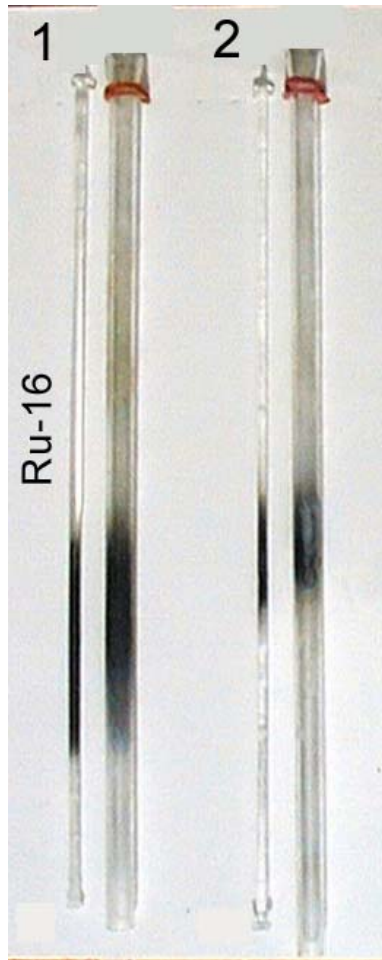

Fig. 11. Deposition of fission products on the inner surface of samplers in the outlet section.

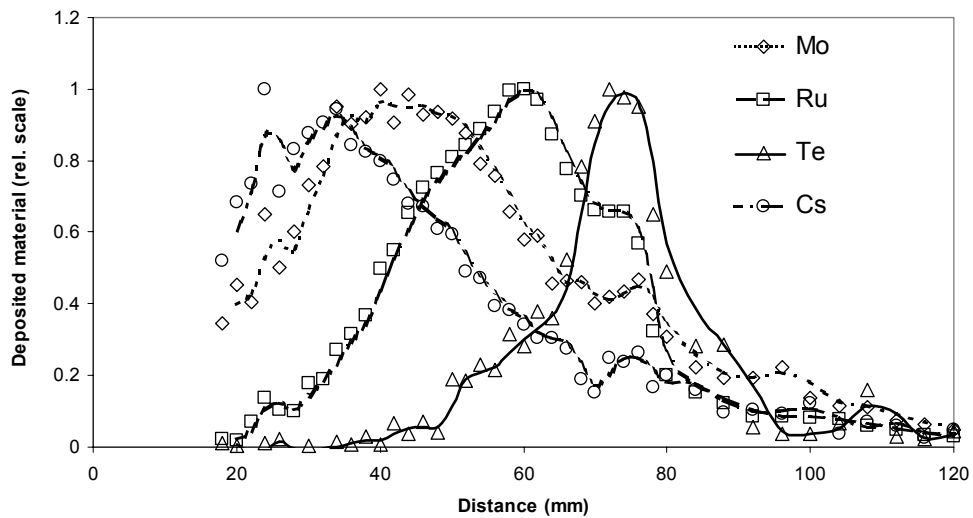

Fig. 12. Axial distribution of deposited fission product elements along the 120-mm-long sampling tube in test Rus-5. The wall temperature is the highest at zero distance and then it gradually decreases.

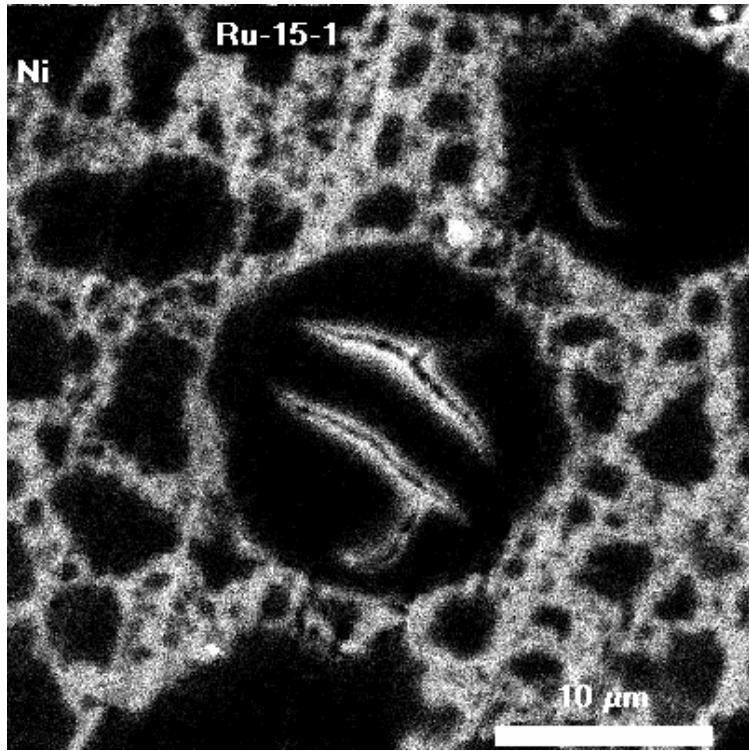

Fig. 13. Digital (BE) image of Ni plate exposed to the effect of iodine.

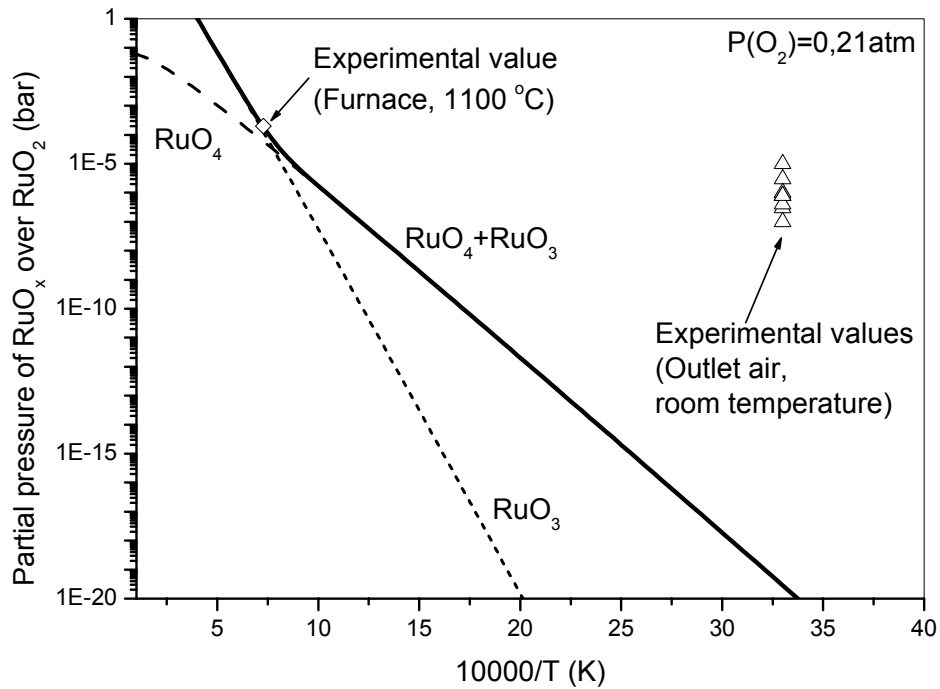

Fig. 14. The partial pressure of volatile Ru oxides as a function of reciprocal temperature. The lines show the equilibrium partial pressures; the hollow symbols refer to the values measured in the tests

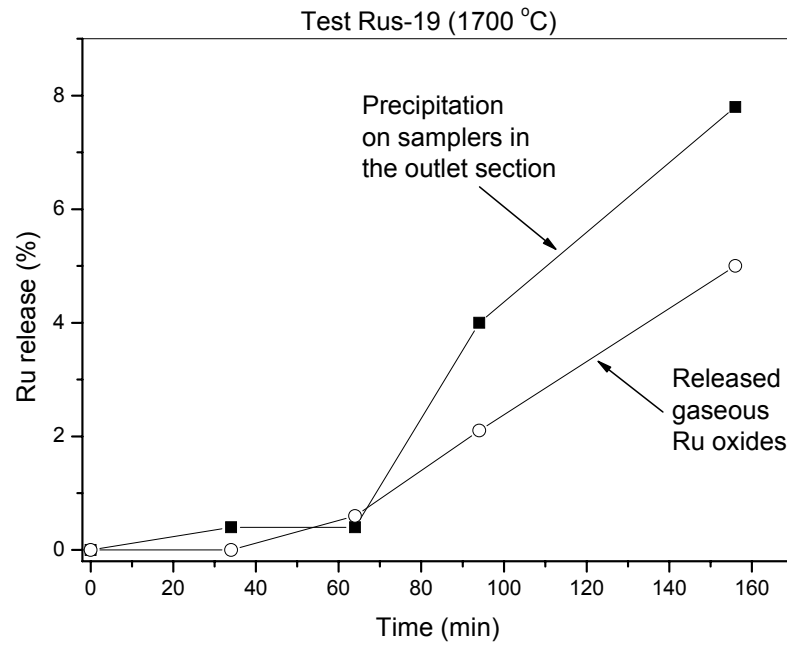

Fig. 15. Integrated Ru release from short fuel rod sample

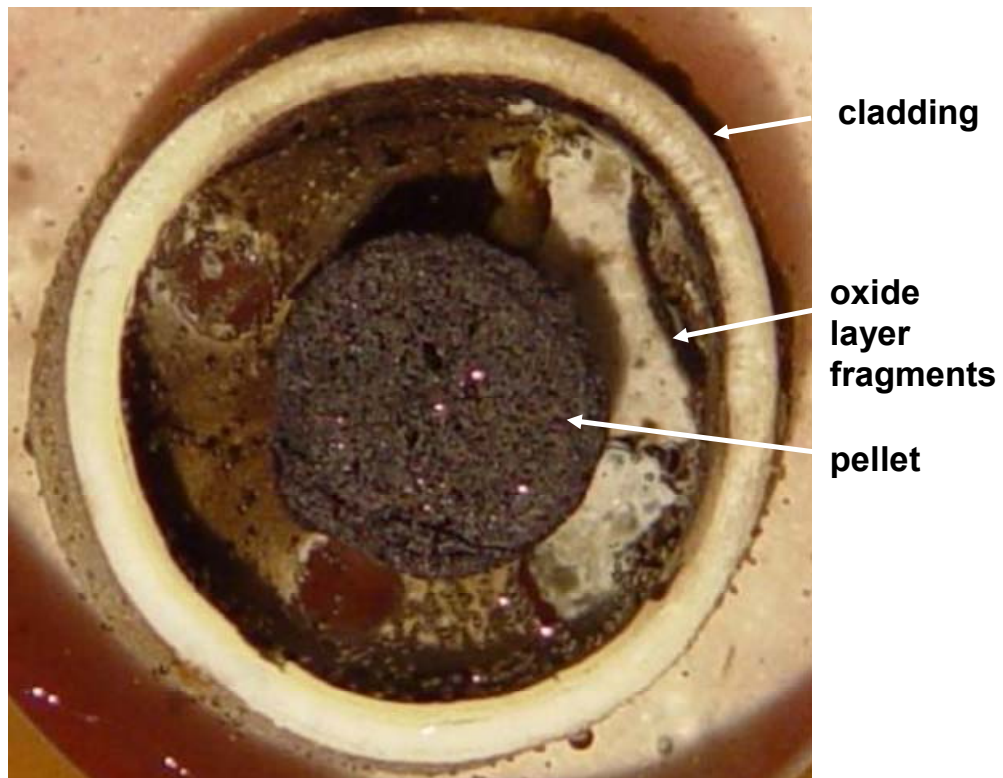

Fig. 16. Cross section of sample Rus-21.