

MANUFACTURING OF COMPOSITES BY PRESSURE INFILTRATION, STRUCTURE AND MECHANICAL PROPERTIES

I. N. Orbulov

PhD student, Department of Materials Science and Engineering, Budapest University of Technology and Economics,
H-1111, Budapest, Goldmann tér 3. Tel: +36 (1) 463 2386, e-mail: orbulov@gmail.com

Á. Németh

Assistant professor, Department of Materials Science and Engineering, Budapest University of Technology and Economics,
H-1111, Budapest, Goldmann tér 3. Tel: +36 (1) 463 1386, e-mail: arpinem@eik.bme.hu

J. Dobránszky

Senior research fellow, Research Group for Metals Technology of the Hungarian Academy of Sciences,
H-1111, Budapest, Goldmann tér 3. Tel: +36 (1) 463 1934, e-mail: dobi@eik.bme.hu

Abstract: This paper presents the possibility of composite block production by using pressure infiltration technology. This method uses the pressure of an inert gas (usually argon or nitrogen) to force the melted matrix material to infiltrate the reinforcing elements. Two types of materials were considered: metal matrix syntactic foam and carbon fibre reinforced metal matrix composite. Physical and mechanical investigations – such as optical microscopy, scanning electron microscopy (SEM), X-ray diffractography (XRD), tensile and upsetting tests (considering aspect ratio) – were performed. The results of measurements are summarized briefly here. Microscopic investigations showed almost perfect infiltration. XRD measurements and tensile tests revealed negative effect of an intermetallic phase (Al_4C_3) on ultimate tensile strength (UTS). Syntactic foams showed plateau region in their upsetting diagrams. The effect of aspect ratio was also investigated. Specimens with higher aspect ratios showed higher peak stress and higher modulus of elasticity. In the case of carbon fibre reinforced metal matrix composites Al_4C_3 ensured high compressive fracture strength

Keywords: *metallic foam, syntactic foam, microballoon, hollow sphere, microsphere, metal matrix composite.*

1. INTRODUCTION

Pressure infiltration technique is a widely used method to produce metal matrix composites (MMCs). This method is used when high volume fraction and uniform distribution of the reinforcing particles or fibres are desired [1-7]. For successful infiltration a threshold pressure must be assured by the infiltrating system. This threshold pressure can be calculated by theoretical approaches for various systems [8-10]. The pressure infiltration technique is used for the fabrication of MMCs with various reinforcements such as particles or fibres. Usually the matrix material is aluminium- or other low-density alloy.

With pressure infiltration one can produce various types of materials for example syntactic foams. Syntactic foams are closed cell foams, and they can be classified as MMC also. The first publication on this material was presented in the early 1960s. In the case of syntactic foams porosity is produced by introducing hollow spheres (microballoons) into the matrix material. Syntactic foams with metal matrix are usually produced by blending method or by pressure infiltration. The advantage of blending method is that the filler volume fraction

is widely variable. The main disadvantage is the non-uniform distribution of the particles (due to density mismatch between matrix and filler material) [11, 12]. With pressure infiltration technique 60 vol% microsphere content can be produced. Syntactic foams are good energy absorbers, mechanical dampers, have low weight, outstanding specific properties, localized failure, etc. They are used as energy absorbers, heat insulators (with polymer matrix), and sound absorbers or as material of hulls in deep-sea applications and aeronautics.

Nowadays fibre reinforced composites are commonly used materials. Most of them produced with polymer matrix and by impregnation method. There are hundreds of tennis rackets, fishing rods and other sport and hobby equipments which are polymer matrix composites with glass or carbon fibre reinforcing. However MMC is better choice when the composite part should work on elevated temperature. MMCs with alumina or carbon fibre reinforcement are common. Alumina is chemically stable and has high tensile strength, but it is rather expensive and has relatively high density. Opposite to this, carbon fibres have low density, higher strength; they are cheap but sensitive to chemical attacks of the molten metal. In aluminium – carbon system Al_4C_3 intermetallic phase can be generated due to insufficient handling during composite fabrication. This intermetallic phase is brittle and has negative effect on the tensile strength of the composite [13]. But, in upsetting tests Al_4C_3 has a beneficial effect due to its needle-like microstructure growing perpendicular to the fibres. This structure constrains the transversal deformation and therefore increases the compressive strength.

The two types of materials mentioned above were fabricated and tested. The authors managed to characterize these materials through micro structural and mechanical investigations.

2. FABRICATION METHOD AND MATERIALS

2.1. Pressure infiltration method

A carbon steel container was filled to half height with the reinforcement. An insulator layer was situated on the top of the reinforcement. Finally an aluminium block was placed into the container. At this time, at least two thermocouples were put in place to control the process through temperature. Then the prepared and filled container was put into the pressure infiltration chamber (Fig. 1). In this chamber, vacuum or gas pressure can be generated. Argon gas was used to provide the required threshold pressure for infiltrating. After inserting the container into the chamber, it was closed and evacuated. During the heating, the vacuum was maintained. The melted matrix metal was formed a liquid cork above the reinforcement. Then Ar gas was let to flow into the chamber and the pressure was increased to a previously sat value. The generated pressure difference above and under the liquid metal cork enforced the metal to infiltrate the reinforcement. After infiltration, the whole system was let to cool down, or the container was removed and cooled by air or water. After cooling, the composite block was removed from the container and finally specimens were machined for the investigations.

2.2. Syntactic foams

Syntactic foam blocks were prepared by using hollow ceramic microballoons as filler and AlSi12Mg aluminium alloy or commercially pure aluminium (cp-Al) as matrix. The hollow ceramic microspheres were supplied by Sphere Services Inc., USA. Bulk density of the microspheres is $\sim 400 \text{ kgm}^{-3}$ and they are in the 130-170 μm diameter range with a mean diameter of 150 μm . Wall thickness is about 15 μm ($\sim 10\%$ of the average diameter). Broken hollow microspheres or shells were removed by buoyancy method. The microspheres

contained 55-65 wt% silica (SiO_2), 25-35 wt% alumina (Al_2O_3), 1-5 wt% iron oxide (Fe_2O_3) and 0.5-1.5 wt% titania (TiO_2). As one can see, the material of the microspheres contains mainly SiO_2 . Usually Al_2O_3 and SiO_2 combine to mullite ($3\text{Al}_2\text{O}_3 \cdot 2\text{SiO}_2$), which is a stable compound in the Al_2O_3 - SiO_2 system. There are more SiO_2 than needed for mullite, that is why mullite embedded in SiO_2 matrix. The microspheres are packed closely, so the volume fraction of them was $\sim 60\%$. In the used diameter and volume fraction range, a pressure of ~ 0.5 MPa was sufficient for infiltration.

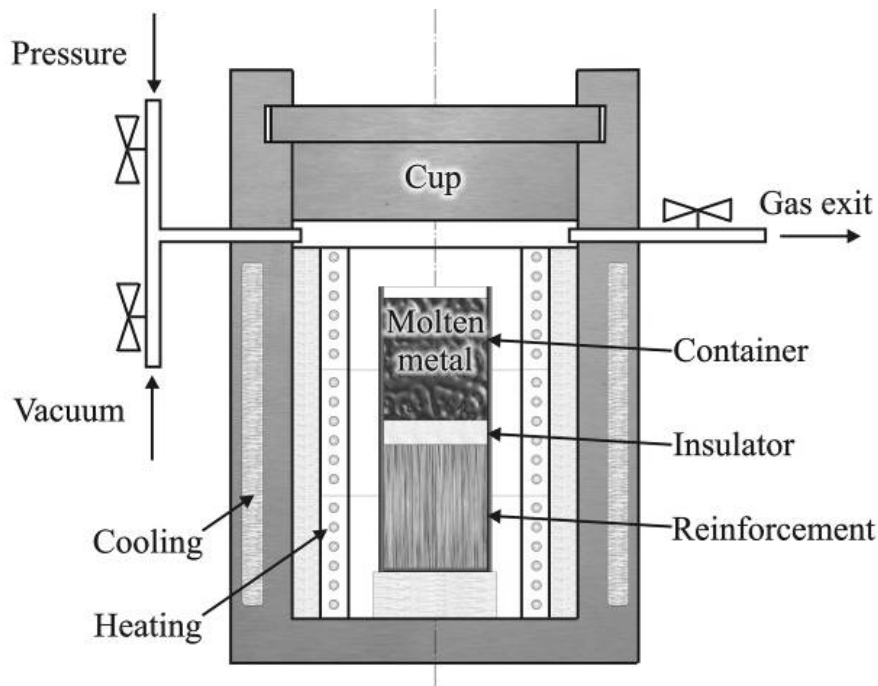

Fig.1. Schematic structure of the infiltration unit

2.3. Fibre reinforced composites

Unidirectionally reinforced composite blocks were prepared by using two types of carbon fibres. Diameter of fibres was $\sim 7-8$ μm . The difference between the fibres was the content of crystalline phase. With a special technique, we could reach over 60% of volume fraction. However, this high volume fraction required high infiltration threshold pressure (~ 8.5 MPa). AlSi12Mg aluminium alloy were used as matrix material. Because it is eutectic alloy, therefore it has good flowability and low melting point. Infiltration temperature is a very important parameter in the aspect of intermetallic phase formation by diffusion. In the case of AlSi12Mg the Mg addition improves flowability and wetting. Trials were made to minimize the dwelling time in the unit after infiltration, because the diffusive reaction between carbon and aluminium is very time dependent. Therefore, after infiltration the container was quickly removed from the infiltration unit and was cooled first by water and after that on air.

3. EXPERIMENTAL METHODS

First of all density of the materials were determined by Archimedes' law, because the aim of this work was to create lightweight structural components. The volume fraction of the filler material (reinforcement) was also measured. Optical microscopic investigations were done to get information about insufficient infiltration, e.g. content of porosity. Researches were made to find evidences of chemical reaction between reinforcement and matrix also. An Olympus PMG-3 type microscope was used for investigations. For detailed results the

microscopic investigations were extended by scanning electron microscopy (SEM, Phillips XL-30). Higher magnification of SEM allowed examining the structure of ceramic hollow microspheres and the surface of carbon fibres in the case of syntactic foams and carbon fibre reinforced MMCs respectively. In the case of carbon fibre reinforced MMCs X-ray diffraction (XRD) measurements were done to determine the quantity of intermetallic phase (Al_4C_3) in the interfacial zones. This is very important because Al_4C_3 has very strong influence on mechanical properties and due to this on the quality of the composite. The measurements were done in the Chemical Research Centre of the Hungarian Academy of Sciences. Phillips PW1740 type diffractometer was applied.

Besides the measurements mentioned above conventional mechanical tests (upsetting tests and tensile tests) were done also. Tiratest 2300 universal testing machine was used to manage these investigations with a 100 kN load cell. In the case of syntactic foams, cylindrical $\varnothing 15$ mm upsetting specimens with aspect ratio of 1, 1.5 or 2 were machined. The crosshead speed was 2 mm/min this corresponds to strain rates of $\sim 0.0022\text{ s}^{-1}$, $\sim 0.0014\text{ s}^{-1}$, $\sim 0.0011\text{ s}^{-1}$ respectively. Thin lubricant layer was applied on the tops and bottoms of the specimens to prevent barrelling. In the case of fibre reinforced composites $\varnothing 10$ mm specimens were used and only one aspect ratio (1.5) was inspected.

For the tensile tests, we used special, $\varnothing 10$ mm cylindrical specimens with an R10 insert (see Fig. 2).

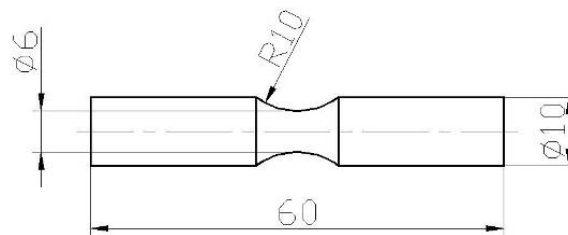

Fig.2. The form of tensile test specimen

4. RESULTS AND DISCUSSION

Density measurements indicated $\sim 1300\text{ kgm}^{-3}$ and $\sim 2250\text{ kgm}^{-3}$ in the case of syntactic foam and carbon fibre reinforced MMCs respectively. Both of them were lighter than the matrix material, so lightweight structures were produced. The volume fraction of hollow microsphere and fibre reinforcement was around 60%, according to image analyzing measurements. Pictures taken during microscopic investigations are shown in Fig. 3-6.

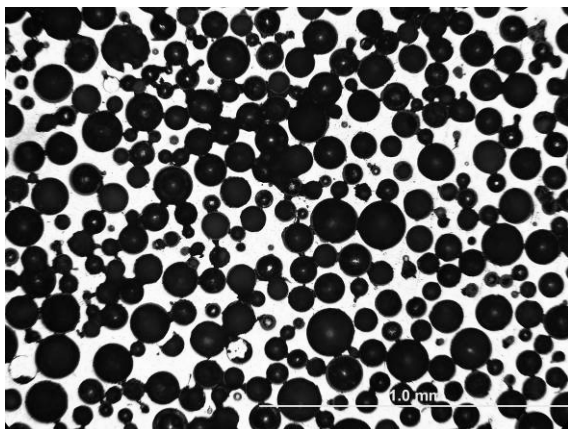

Fig.3. Overall picture of syntactic foams

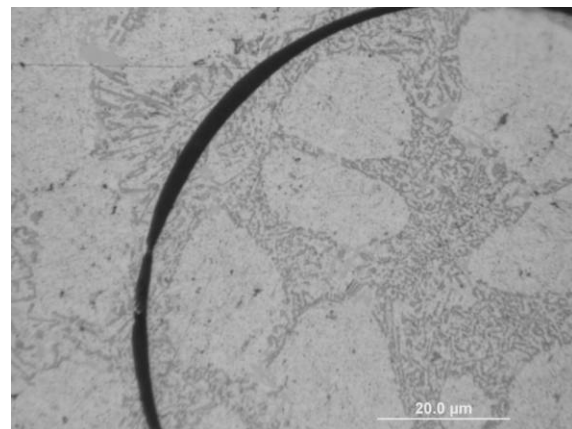

Fig.4. Ceramic hollow microsphere in AlSi12Mg

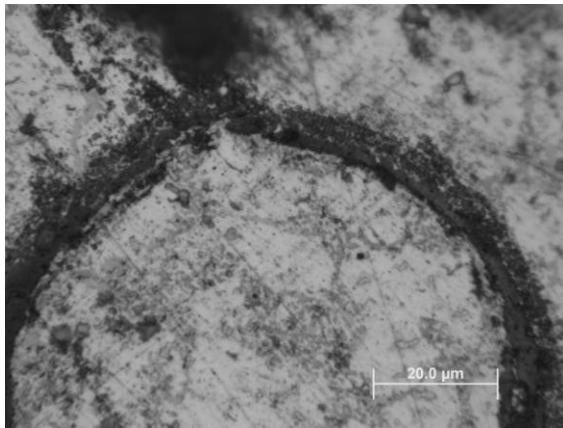

Fig.5. Ceramic hollow microsphere in cp-Al

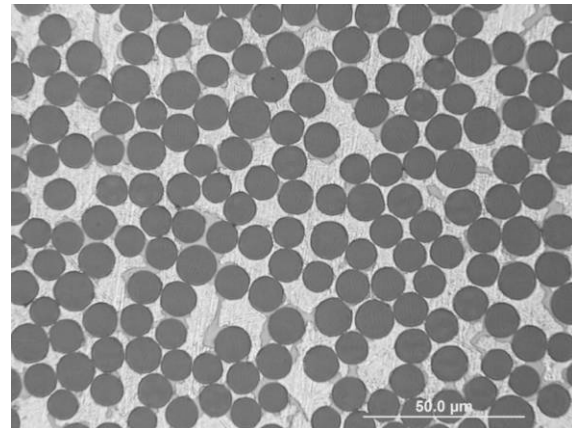

Fig.6. Cross section of carbon fibre reinforced MMC

In Fig. 3 an overall picture of syntactic foams is shown. The matrix is AlSi12Mg and one can notice only a few broken shells. Speaking in general, the infiltration was successful however; some porosity can be noticed between closely packed hollow spheres. The spheres have defined contour, and it means there were no significant reaction between the matrix and them. This is confirmed by the next picture. In Fig. 4 the wall of a hollow microsphere is shown in AlSi12Mg. The wall looks unharmed and it indicates that there is no interface layer between the shell and the eutectic matrix. Opposing to this Fig. 5 shows undisposed microsphere wall in cp-Al matrix. The Si concentration mismatch between the microsphere wall and matrix is the driving force of the chemical reaction $4Al+3SiO_2 \rightarrow 3Si+2Al_2O_3$. This shows Al_2O_3 formation, what is advantageous, but not at a price of disordering the wall. Fig. 6 shows the cross section of a carbon fibre reinforced MMC. The high volume fraction of reinforcement is evident. There are no porosities between the fibres, so the infiltration was sufficient. Darker gray areas can be observed in the matrix, which are Si precipitations. Usually Si precipitations start to grow from the surface of fibres. In these regions, the cohesion is weaker between the matrix and fibres.

Detailed results were achieved by using SEM. Fig. 7-10 show high magnification pictures, which were taken during SEM investigations. In Fig. 7 an overall picture of syntactic foams can be seen. One can notice the hollow spheres are well embedded in the matrix, only a very few porosity can be observed between the closely packed spheres. In Fig. 8 the broken wall of hollow ceramic microspheres can be seen. The walls of microspheres have micro porosities. This is very important, because porosity has crucial effect on the density and mechanical properties of syntactic foams.

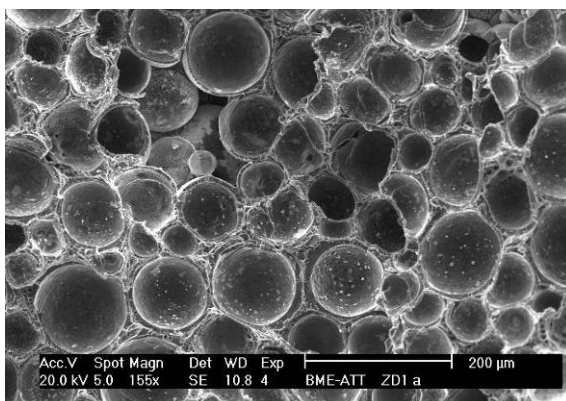

Fig.7. Overall SEM picture of syntactic foams

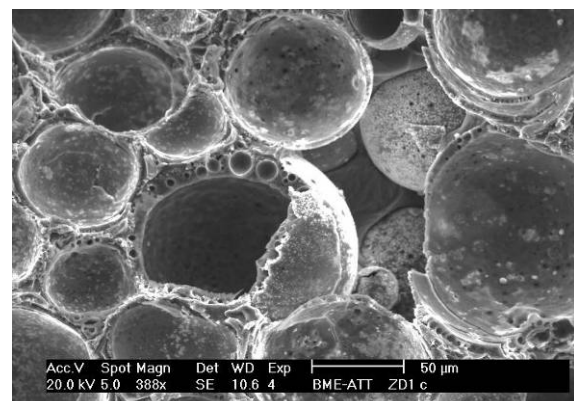

Fig.8. Ceramic hollow microspheres in AlSi12Mg

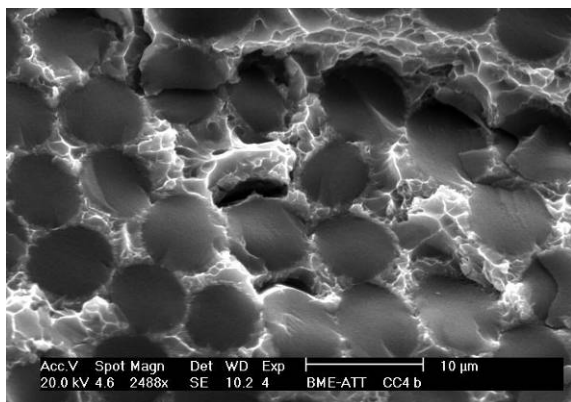

Fig.9. Fracture surface of carbon fibre reinforced MMC (tensile specimen)

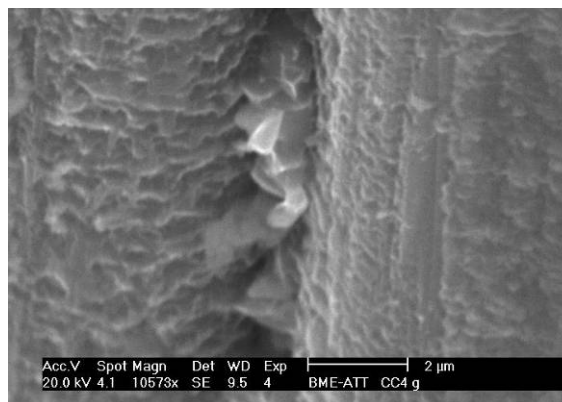

Fig.10. Surface of carbon fibres in MMC

If the porosity increases, the compressive strength will decrease, but the length of the plateau region will be extended. This leads to the approximately same absorbed energy, but the character of energy absorbing will change significantly. The third SEM picture (Fig. 9) shows the fracture surface of a fibre reinforced tensile specimen. Uniformly distributed carbon fibres can be observed. Two – not generally appearing – impurities can be noticed. One can notice the matrix had ductile fracture, while the fibres were broken rigidly. Usually the fractures were perpendicular to the longitudinal axes of the specimens and propagated through parallel layers. Between the parallel layers, fractures were moved along the fibres, usually in the interfacial region of the fibres and matrix material. In Fig. 10 the surface of carbon fibres can be examined in details, the surface is rather ragged. This increases the possibility of Al_4C_3 formation. During Al_4C_3 formation, the amount of amorphous carbon phase in the carbon fibres is crucial factor as proved by XRD measurements.

XRD measurements show that in MMCs with carbon fibres, which have higher amorphous carbon phase content, higher quantity of Al_4C_3 was developed (Table 1).

Description	Al [%]	Si [%]	Al_4C_3 [%]	C [%]
MMC with carbon fibres containing <i>low</i> quantity of amorphous carbon	56	5.5	0.5	38
MMC with carbon fibres containing <i>high</i> quantity of amorphous carbon	48	7	9	36

Table 1. Results of XRD measurements

Carbon fibre containing higher quantity of amorphous phase produced 18 times higher amount of Al_4C_3 . In amorphous carbon, preferred crystallographic planes for Al_4C_3 development appear with higher probability. Therefore, more Al_4C_3 can be produced.

The recorded diagrams and pictures of fracture surfaces of tensile test specimens are shown in Fig. 11 and Fig. 12. These are general curves and characterize the behaviour of the materials well. Both types of materials have shown brittle fracture. The surfaces have shown brittle fracture also. The ultimate tensile strength (UTS) was low in the case of foams, and higher in the case of MMC as expected. Due to Al_4C_3 formation, UTS of carbon fibre reinforced MMCs have not exceeded the calculated UTS by the rule of mixture (ROM). The Al_4C_3 crystals – which are perpendicular to the fibre – are exposed to bending during tensile tests. When a critical bending stress is reached the needle-like Al_4C_3 crystals are broken near or at the contact points on the fibres. Due to this, the fibres are broken also, and the composite has been degraded.

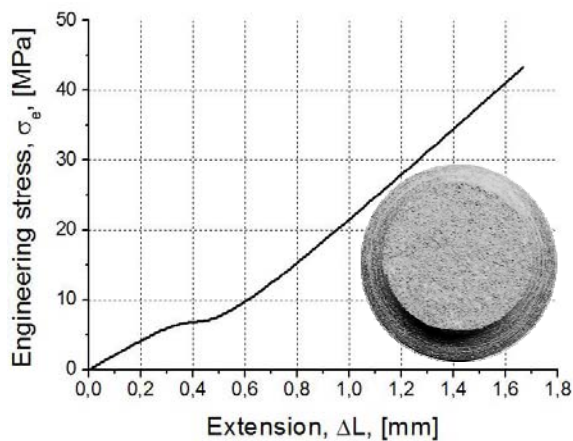

Fig.11. Tensile test diagram of syntactic foam containing microspheres

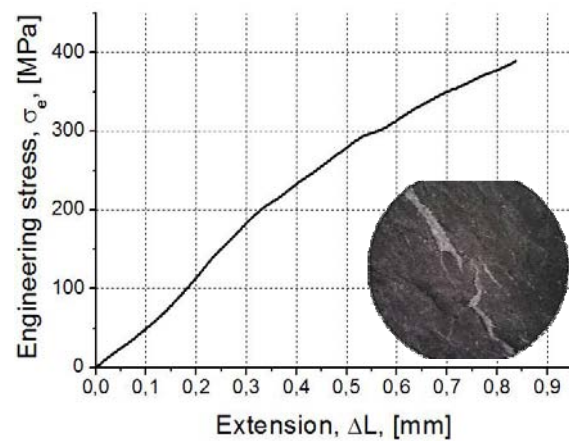

Fig.12. Tensile test diagram of fibre reinforced MMC

Upsetting tests were also done to explore the mechanical energy absorbing properties of both materials. In the case of foams this is the main loading type. Both material types has absorbed approximately the same specific mechanical energy ($\sim 30\text{-}40 \text{ Jg}^{-1}$) but by different way. Syntactic foams showed relatively long plateau after initial linear period. The plateau was followed by densification. A general upsetting diagram is shown in Fig. 13. The first peak in the recorded diagram corresponds to the forming of the initial crack in the specimen. The plateau stress was maintained by sliding of the two specimen-halves (formed by the initial crack) on each other.

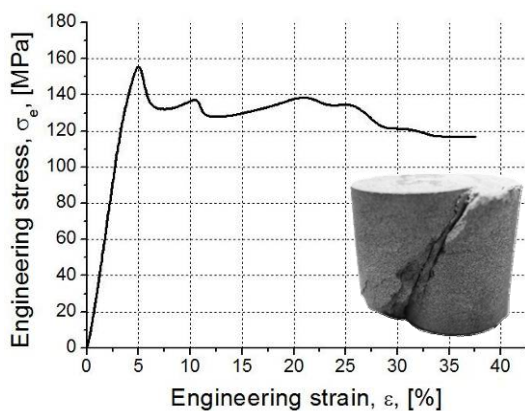

Fig.13. Upsetting test diagram of syntactic foam containing microspheres

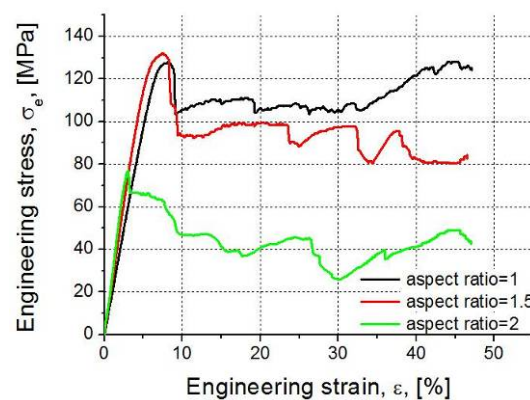

Fig.14. Upsetting test diagram of syntactic foam with different aspect ratios

In Fig. 14 the effect of aspect ratio is shown. One can notice minimal difference between the initial moduli of elasticity. The average value of modulus was 19.37, 23.57 and 28.85 MPa in the case of aspect ratios 1, 1.5 and 2 respectively. Upsetting specimens with aspect ratio of 1 and 1.5 showed the same peak stress, specimen with aspect ratio 2 showed lower peak stress and somewhat different behaviour, but higher modulus of elasticity. Each specimen was compressed near to the half of the initial height. In the case of higher aspect ratios more cracks occurred. Every significant stress alternation in the diagram (Fig. 14) signs the formation of a new crack. On the other hand the damage of the foams can be monitored by X-ray tomography and acoustic emission investigations also [14, 15].

In the case of carbon fibre reinforced MMCs brittle fracture and high compressive stresses were observed (see Fig. 15). This is due to Al_4C_3 formation. Needle like Al_4C_3

crystals growing perpendicular to the fibres constrains lateral deformation and therefore the compressive strength strongly increased.

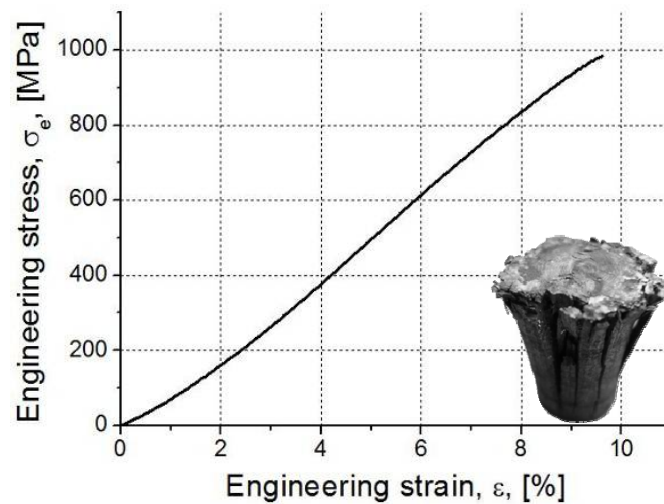

Fig.15. Upsetting test diagram of fibre reinforced MMC

5. CONCLUSIONS

Syntactic foams and carbon fibre reinforced MMCs were successfully produced by pressure infiltration method.

- Microscopic investigations showed negligible quantity of undesirable impurities in the case of both material types.
- Some reaction between ceramic hollow spheres and matrix material was observed in cp-Al systems. Al_4C_3 formation was also noticed in carbon – Al alloy systems. XRD measurements showed that, the quantity of Al_4C_3 formatted depends on the amorphous carbon content in carbon fibres.
- The presence of Al_4C_3 crystals had negative effect on the UTS as showed by tensile tests and positive effect on compressive strength as showed by upsetting tests. Al_4C_3 also caused large deviation in the mechanical properties.
- During upsetting tests, syntactic foams showed plateau region in their compressing diagrams at relatively high stress levels. This and the fracture behavior indicate that, the failure mechanism is combined (compression and shear).
- Aspect ratio has significant effect on the most important mechanical properties like peak stress and modulus of elasticity. Increasing aspect ratio results higher modulus of elasticity. Specimens with aspect ratio 1 and 1.5 showed higher (and approximately equal) peak stresses than specimens with aspect ratio 2.
- Aspect ratio has effect on crack developing and on the plateau region also. Increasing aspect ratio causes more cracks; the plateau region becomes less stable.

ACKNOWLEDGEMENTS

The authors would like to thank J. T. Blucher for his assistance support. The Metal Matrix Composites Laboratory is supported by grant # GVOP 3.2.1-2004-04-0145/3.0. The investigations were supported by grant # OTKA 69122. Special thanks to I. Sajó for XRD measurements. Thanks to Róbert Tóth and C. H. Erbslöh Hungária Speciality and Industrial Minerals Ltd. for support.

REFERENCES

- [1] J. T. Blucher, J. Dobranszky, U. Narusawa: Aluminium composite structures reinforced with composite wires, *Materials Science and Engineering A*, 2004, 387-389, pp. 867-872
- [2] I. Kientzl, J. Dobranszky, J. Ginsztler: Heat treatment and impact testing of composite wires, *Key Engineering Materials*, 2007, 345-346, pp. 1273-1276
- [3] P. K. Rohatgi, J. K. Kim, N. Gupta, S. Alaraj and A. Daoud: Compressive characteristics of A356/fly ash cenosphere composites synthesized by pressure infiltration technique, *Composites Part A: Applied Science and Manufacturing*, 2006, 37, pp. 430-437
- [4] P. K. Rohatgi, R. Q. Guo, H. Iksan, E. J. Borchelt, R. Asthana: Pressure infiltration technique for synthesis of aluminium – fly ash particulate composite, *Materials Science and Technology A*, 1998, 244, pp. 22-30
- [5] D. K. Balch, D. C. Dunand: Load partitioning in aluminium syntactic foams containing ceramic microspheres, *Acta Materialia*, 2006, 54, pp. 1501-1511
- [6] D. K. Balch, J. G. O'Dwyer, G. R. Davis, C. M. Cady, G. T. Gray III., D. C. Dunand: Plasticity and damage in aluminium syntactic foams deformed under dynamic and quasi-static conditions, *Materials Science and Engineering A.*, 205, 391, pp. 408-417
- [7] R. A. Palmer, K. Gao, T. M. Doan, L. Green, G. Cavallaro: Pressure infiltrated syntactic foams – Process development and mechanical properties, *Materials Science and Engineering A.*, 2007, 464, pp. 85-92
- [8] T. Bárczy, Gy. Kaptay: Modelling the infiltration of liquid metals into porous ceramics, *Materials Science Forum*, 2005, 473-474, pp. 297-302
- [9] Gy. Kaptay: The threshold pressure of infiltration into fibrous preforms normal to the fibers' axes, *Composite Science and Technology* 2008, 68, pp. 228-237
- [10] V. Michaud, A. Mortensen: Infiltration processing of fibre reinforced composites: governing phenomena, *Composites Part A.*, 2001, 32, pp. 981-996
- [11] M. Ramachandra, K. Radhakrishna: Effect of reinforcement of fly ash on sliding wear, slurry erosive wear and corrosive behaviour of aluminium matrix composite, *Wear*, 2007, 262, pp. 1450-1462
- [12] M. Ramachandra, K. Radhakrishna: Synthesis – microstructure – mechanical properties – wear and corrosion behaviour of an Al-Si (12%) – fly ash metal matrix composite, *Journal of Materials Science*, 2005, 40, pp. 5989-5997
- [13] E. Pippel, M. Doktor, J. Blucher, H. P. Degischer: Interlayer structure of carbon fibre reinforced aluminium wires, *Journal of Materials Science*, 2000, 35, pp. 2279-2289
- [14] Cs. Kádár, F. Chmelík, J. Lendvai, Zs. Rajkovits: Acoustic emission measurements on metal foams, *Journal of Alloys and Compounds*, 2004, 378/1-2, pp. 145-150
- [15] Cs. Kádár, E. Maire, A. Borbély, G. Peix, J. Lendvai, Zs. Rajkovits: X-ray tomography and finite element simulation investigations of the indentation behaviour of metal foams, *Materials Science and Engineering A*, 2004, 387-389C, pp. 321-325